

i-PIX

BB 3



The BB 3 is an original fixture design from lighting people for lighting people with an environmental conscience.

The BB 3 is a powerful led fixture with a new generation of combined RGB high power leds with homogenized output. Designed for a life on tour and packed full of control versatility and rigging/ de-rigging simplicity. This fixture can be used outdoors as well as indoor in fixed installations or traveling around the world.

KEY FEATURES

- Energy efficient additive colour mixing and static colour device
- customised RGB LED
- Efficient heat dissipation of both led heat and control section
- Self contained device
- Built in user interface for additional functionality
- Built in functions for dmx use and stand alone use
- A variety of different operating modes are provided for differing applications
- Super fast strobe from constant on to a slow pulse, colour oscillations are possible
- 2 x 20° interchangeable optics as standard
- Choice of 10°, 35° & 45° interchangeable optics also available
- Accessory slot for optical accessories such as asymmetric beam adjuster
- Easy connect of data with 5pin xlr's from supplied splitters
- Easy power input and output for daisy chaining adjacent units 16 amps max from splitters provided
- Combined data and power cable chassis connections for tidy single cable setups
- Stand alone function provides memory storage
- A stand alone chase sequence of using specified memories
- Auto ranging power input 100v to 240 volts, ideal for touring globally
- Dual safety points provided as standard
- Flightcase packages available along with accessories

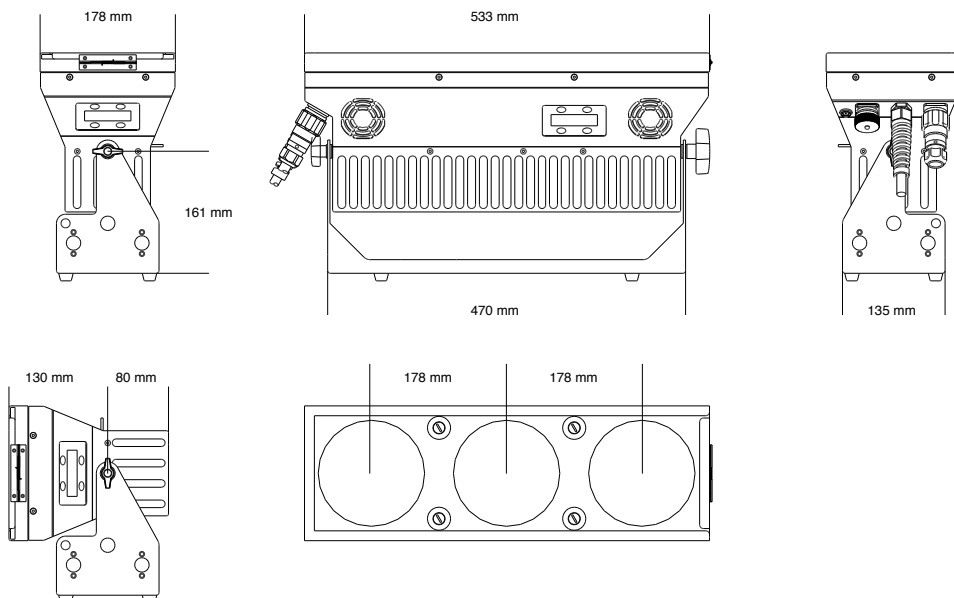

Dimensions:

▪ Length	533 mm
▪ Height	291 mm
▪ Width	178 mm
▪ Weight	11.4Kg

Mechanical design & materials:

▪ Batten	aluminium shrouded finned diagonal heatsink
▪ Yoke	folded and welded steel
▪ Finish	Electro static powder coated black satin

Rigging:

▪ Style	12 ¼ turn camloc fasteners
▪ Number of positions	9 rigging locations on yoke
▪ Accessory holder	fitted with sprung retention flap
▪ Conventional mounts	2 of 12mm bolt holes fitted at each yoke end
	Note: unit comes with two Omega rigging brackets to accept 12mm bolts,

Electrical:

▪ Input	90- 265 Volt 50/60 Hz
▪ Current	0.5 amps @ 240 volts
▪ Power	90 watts total power on full @ 240 volts
▪ Fuse	20mm x 5mm slow blow 2 amp
▪ Input	trailing male IP67 6 pin (Combined power and data connection)
▪ Output	chassis mounted female IP67 6 pin (Combined power and data connection)
	Note; units comes complete with 16 amp plug and 5 pin male.

Control:

	RGB additive colour mixing
▪ DMX channels	3 channels minimum 18 channels maximum
▪ User interface	weatherproof backlit lcd display with four membrane switches
▪ Data type	USITT DMX512-A

Output:

▪ Source	customised RGB LED light engine
▪ Optics	3 x 20° optics with 10°,35° & 45° also available

Thermal characteristics:

▪ Operating temperature	force air cooled via low airflow/ low noise fans Minimum: -20 degrees C, Maximum:+ 46 degrees C
-------------------------	--

Weather protection:

▪ Humidity max	Rated to IP65 20% ~ 90% RH non-condensing
----------------	--

Approvals & Compliance:

BS EN 55103-1	Harmonics
BS EN 55103-2	Immunity
BS EN 61000-3-2	Emissions
USA / Canada	ETL pending

Photometrics for RGB+40% BB 3

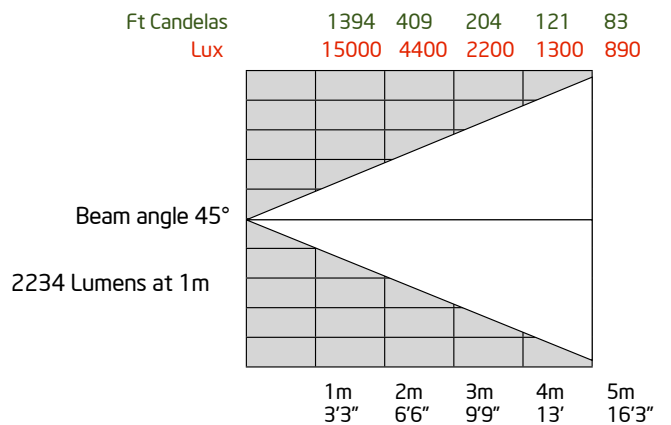
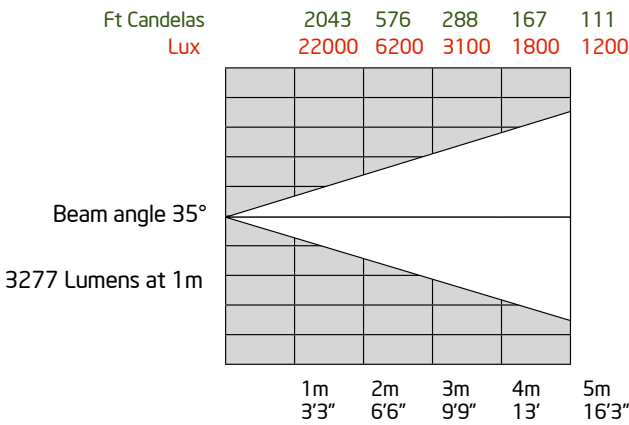
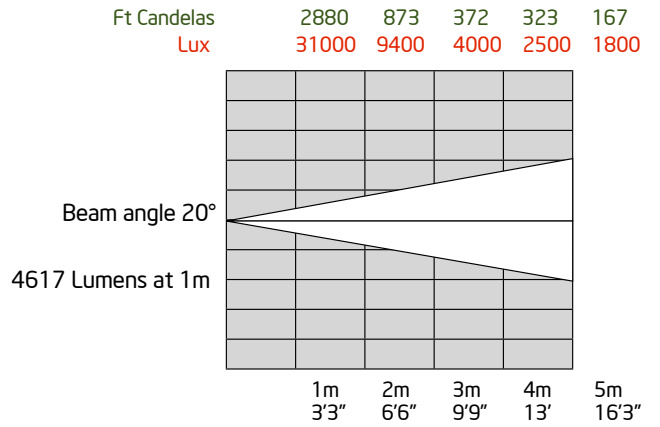
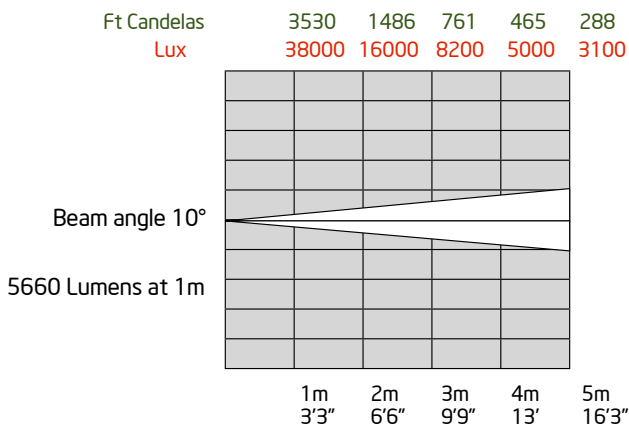

Photometrics for Warm White 3600°K BB 3

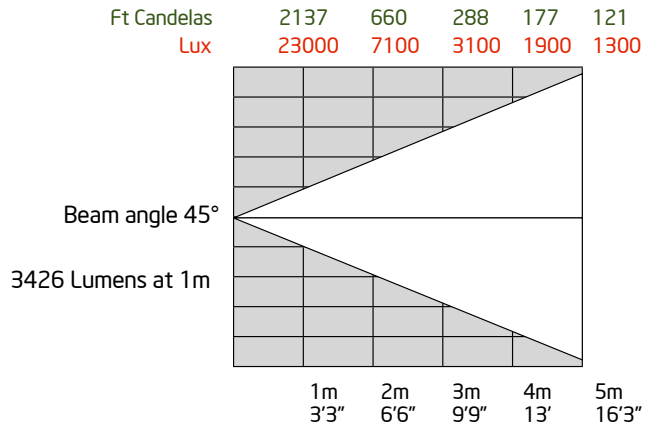
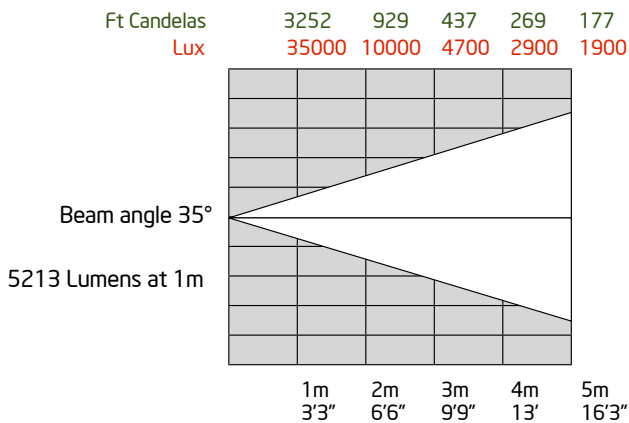
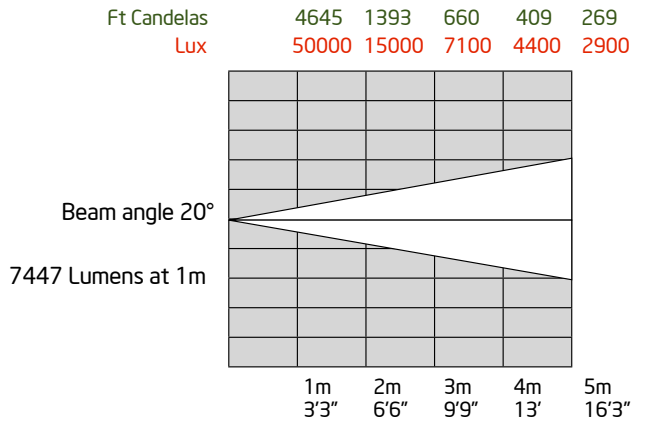
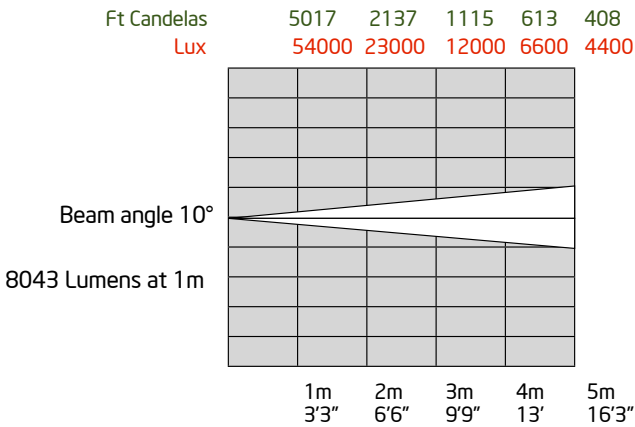

Photometrics for Daylight White 6500°K BB 3

